

DIGITAL
TO
ANALOG
CONVERTER

SANYO

DIR-2000

Digital Box Owner's Manual



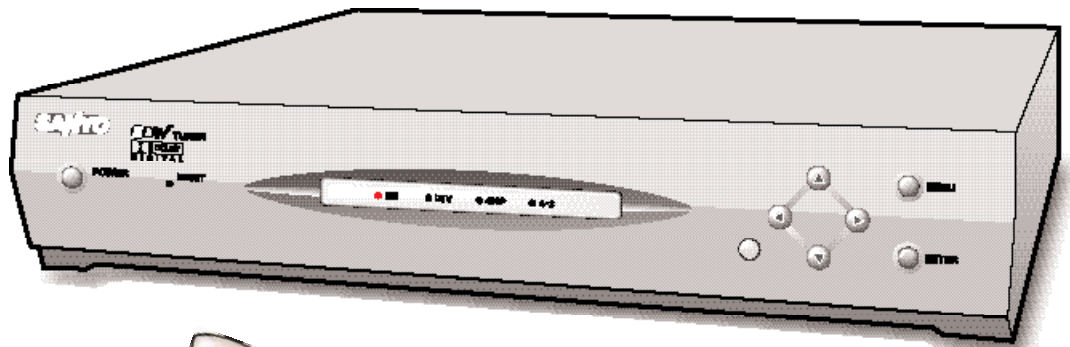

ENHANCED
DEFINITION
TELEVISION
(EDTV)



"As an ENERGY STAR® Partner, Sanyo Manufacturing Corporation has determined that this product meets the ENERGY STAR® guidelines for energy efficiency."

Printed in U.S.A. SMC, May 2002
Part No. : 1JC6P1P0109--
Service Code : 610 297 0548

CAUTION RISK OF ELECTRIC SHOCK DO NOT OPEN	THIS SYMBOL INDICATES THAT DANGEROUS VOLTAGE CONSTITUTING A RISK OF ELECTRIC SHOCK IS PRESENT WITHIN THIS UNIT.	
CAUTION: TO REDUCE THE RISK OF ELECTRIC SHOCK, DO NOT REMOVE COVER (OR BACK). NO USER-SERVICEABLE PARTS INSIDE. REFER SERVICING TO QUALIFIED SERVICE PERSONNEL.	THIS SYMBOL INDICATES THAT THERE ARE IMPORTANT OPERATING AND MAINTENANCE INSTRUCTIONS IN THE LITERATURE ACCOMPANYING THIS UNIT.	

WARNING: TO REDUCE THE RISK OF FIRE OR ELECTRIC SHOCK, DO NOT EXPOSE THIS APPLIANCE TO RAIN OR MOISTURE.

IMPORTANT SAFETY INSTRUCTIONS

CAUTION: PLEASE ADHERE TO ALL WARNINGS ON THE PRODUCT AND IN THE OPERATING INSTRUCTIONS. BEFORE OPERATING THE PRODUCT, PLEASE READ ALL OF THE SAFETY AND OPERATING INSTRUCTIONS. RETAIN THIS LITERATURE FOR REFERENCE. Follow all instructions...

Positioning the appliance

1. Do not place your appliance on an unstable cart, stand, shelf or table. Serious injury to an individual, and damage to the appliance, may result if it should fall. Your salesperson can recommend approved carts and stands or shelf and wall mounting instructions. An appliance and cart combination should be moved with care. Quick stops, excessive force, and uneven surfaces may cause the appliance and cart combination to overturn. 
2. Slots and openings in the cabinet and in the back or bottom are provided for ventilation. To ensure reliable operation of the appliance and to protect it from overheating, these openings must not be blocked or covered. The openings should never be covered with a cloth or other material, and the bottom openings should not be blocked by placing the unit on a bed, sofa, rug, or other similar surface. This appliance should never be placed near or over a radiator or heat register. This appliance should not be placed in a built-in installation such as a bookcase unless proper ventilation is provided.
3. Do not expose the appliance to rain or use near water . . . for example, near a bathtub, swimming pool, kitchen sink, in a wet basement, etc.

Plug in the power cord

5. This product should be operated only from the type of power source indicated on the marking label. If you are not sure of the type of power supply to your home, consult your product dealer or local power company. This product is equipped with a polarized alternating current line plug (a plug having one blade wider than the other). This plug will fit into the power outlet only one way. This is a safety feature. If you are unable to insert the plug fully into the outlet, try reversing the plug. If the plug should still fail to fit, contact your electrician to replace your obsolete outlet. Do not defeat the safety purpose of this polarized plug. Do not overload wall outlets, extension cords, or integral convenience receptacles as this can result in a risk of fire or electric shock.
6. Power-supply cords should be routed so that they are not likely to be walked on or pinched by items placed upon or against them, paying particular attention to cords at plugs, convenience receptacles, and the point where they exit from the product.

Cleaning

7. Before cleaning, unplug the unit from the wall outlet. Do not apply liquid cleaners or aerosol cleaners directly to the unit. Use a dry cloth for cleaning.

Service & Repair

8. Unplug the appliance from the wall outlet and refer servicing to qualified service personnel under the following conditions:
 - A. If the power cord or plug is damaged or frayed.
 - B. If liquid has been spilled into the appliance.
 - C. If the appliance has been exposed to rain or water.
 - D. If the appliance has been dropped or the cabinet has been damaged.
 - E. If the appliance exhibits a distinct change in performance.
 - F. If the appliance does not operate normally by following the operating instructions, adjust only those controls that are covered in the operating instructions. Improper adjustment of other controls may result in damage and will often require extensive work by a qualified technician to restore the appliance to normal operation.
9. Upon completion of any service or repair, request the service technician's assurance that only Factory Authorized Replacement Parts that have the same characteristics as the original parts were used, and that routine safety checks have been performed to determine that the appliance is in safe operating condition. Unauthorized substitutions may result in fire, electrical shock, or other hazards.
10. Never add accessories that have not been specifically designed for use with this appliance as they may cause hazards.
11. For added protection during a lightning storm, or when the set is left unattended and unused for long periods of time, unplug it from the wall outlet and disconnect the antenna. This will prevent damage to the set due to lightning or power line surges.
12. Never push objects of any kind into this product through openings as they may touch dangerous voltage points or short-out parts that could result in a fire or electric shock. Never spill liquid of any kind on the product.

EXAMP
ACCOR
ELECTI
ANSI/N

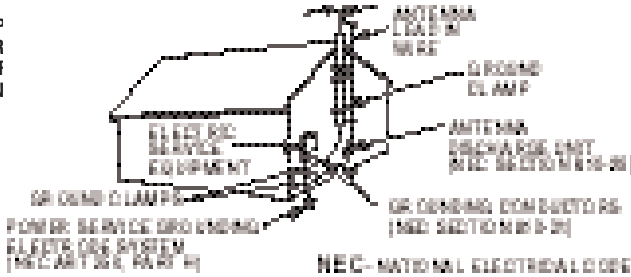

"Note to CATV system installer:
This reminder is provided to call the CATV system installer's attention to Article 820-40 of the NEC that provides guidelines for proper grounding and, in particular, specifies that the cable ground shall be connected to the grounding system of the building, as close to the point of cable entry as practical."

Hooking Up Outdoor Antenna

LIGHTNING PROTECTION FOR YOUR ANTENNA AND SET AS PER NATIONAL ELECTRICAL CODE INSTRUCTIONS.

4. If an outside antenna is connected to the receiver, be sure the antenna system is grounded so as to provide some protection against voltage surges and built up static charges. Article 810 of the National Electrical Code, ANSI/NFPA 70, provides information with respect to proper grounding of the mast and supporting structure, grounding of the lead in wire to an antenna discharge unit, size of grounding conductors, location of antenna discharge unit, connection to grounding electrodes, and requirements for the grounding electrode.
An outside antenna system should not be located in the vicinity of overhead power lines or other electric light or power circuits, or where it can fall into such power lines or circuits. When installing an outside antenna system extreme care should be taken to keep from touching such power lines or circuits as contact with them might be fatal.

Contents

Important Safety Instructions	2	Feature Setup	
Introduction — Welcome to the World of Sanyo	3	Setting the Clock/Day	15
Glossary	4	Digital Audio Out	15
Features	5	Setting the Menu Language	16
Specifications	5	System Information	16
Basic Startup and		Other Feature Operation	
Connections	Refer to Quick 'N Easy Startup Guide	Using the Channel Map	16
Understanding the DIR-2000 Features	6~8	Express Channel Selection	17
Using the Remote Control	9~10	Selecting a Direct Channel	18
SDB Menu Operation	11~16	Selecting a (-) Sub Channel	
General Menu Operation	11	Major/Minor Channels	18~19
Picture Adjustment		Audio Reception	19
Aspect Ratio (Width to Height)	12	V-Guide Operation	20
Pix Shape	12	SDB Output Jacks Connection	21
Scan Mode	12	Resetting the SDB	21
Channel Operation		Closed-Captioning	
Channel Search	13	Selecting Caption Options	22
Channel Scan Memory	13	Care and Cleaning	22
Initial Channel setup	14	Troubleshooting	23
Channel Display Banner Info	14	Index	23
		Warranty and Service	24

Introduction

Welcome to the World of Sanyo

Thank you for purchasing the Sanyo Digital Box (SDB). You made an excellent choice for Performance, Reliability, Features, Value, and Styling.

To The Owner

We are aware that you are eager to begin using your new SDB. However, we also understand that to enjoy it fully you must first understand its many features. While this owner's manual is intended to fully acquaint you with the SDB's operation, it is not meant to be read from cover to cover. Instead, it has been carefully arranged for easy use so you can quickly move on to enjoying your SDB.

Glossary

Aspect Ratio—The aspect ratio of a television picture is the relationship of the width to the height. The standard *Analog* aspect ratio is 4:3. The 16:9 aspect ratio appears wider and shorter, more closely resembling a movie theater screen image.

ATSC—Advanced Television Standards Committee.

Brief Banner—Station ID channel number, and time display that appears when changing channels.

Brief Channel Number Display—The small display that appears when entering channel numbers.

Category Tab Area—Tabs are located at the top of each main on-screen display: Menu, CHannel Map, or V-Guide.

Channel Search—This process establishes the basic database. The search process looks for available channels in both tuning systems (DTV and NTSC). If a signal is present, the channel is added to the database. The database will be entirely reset anytime a full Channel Search is completed. If the search is started from the Menu, then the display returns to the Menu after the search is finished.

CHannel Scan Memory—This is a list of active channels that is created during the Channel Search process and stored in memory. Viewers can scan through this list using the Up/Down Scan keys.

This area is also used to delete unwanted channels. (Channels viewers want to skip over when scanning.) However, to undelete a channel, another Channel Search will need to be completed. For DTV, the CHannel Scan Memory will include only major channel numbers.

CHannel Map—This displays pages of ALL available channels in the database and their status. Channels that have been removed from the CHannel Scan Memory will appear as blue numbers. Any channel can be selected from the CHannel Map, even the “blue” channels.

For DTV, the CHannel Map will show only major channel numbers.

Channel Number Entry Area—This area is used to actually select a channel number when adjusting or setting the Scan Memory and Initial Channel features.

Channel NightScan—NightScan searches for new DTV channels and adds them to the channel database. This search will be performed at random intervals (during an inactive time).

Cursor Keys—The CURSOR keys are the four arrow keys on the remote control and on the SDB front panel. When accessing any page, menu option, or condition, the front panel keys and the remote control keys operate identically.

DTV—Digital Television. Picture is transmitted in a digital format that is sharp and crystal clear.

DTV Indicator—Indicates a digital (ATSC) channel is being received by the SDB.

Direct Channel Selection—This allows the viewer direct access to DTV and NTSC channels. Use the 0-9 number keys to directly enter a new channel number. Use the (-) SUB CH key when necessary.

HDTV—High Definition Television. Picture is transmitted in a highly defined format.

Initial Channel—This feature allows the customer to select a specific channel for the SDB to tune each time the unit is switched on. If not set, the last watched channel will be selected.

NTSC—National Television Standards Committee.

OSD—On Screen Display.

PCM—Pulse Code Modulation is a binary digital signal format used for digitizing analog data. The SDB outputs PCM audio signal from digital audio output. This is the default digital audio output signal.

SDB—Sanyo Digital Box.

S/P DIF—S/P DIF is a digital audio format which can transmit a Dolby Digital bitstream. By connecting this output to an AV receiver that includes a Dolby Digital decoder, you can reproduce up to 5.1 channel surround sound.

Tuner Indicator—A single character “D” or “C” will appear directly to the left of the channel number. Channels selected with the digital (DTV) tuner will be identified with a “D.” Channels selected with the analog (NTSC) tuner will be identified with a “C” if cable or will be blank if Off-Air (VHF/UHF).

Tuner Key—This key is used to switch between only two choices (the ATSC tuner and NTSC tuner).

480P Indicator—Indicates that the progressive video scan option is selected.

4:3 Indicator—Indicates the 4:3 option is selected for the aspect ratio.

Features and Specifications

Convenient Features:

- ◆ Dual Tuning Systems
 - DTV terrestrial digital ATSC (18 formats)
 - NTSC analog (Cable 1~125), (VHF/UHF)
- ◆ Audio formats: Dolby Digital for DTV and analog for NTSC
- ◆ NightScan automatically updates DTV channels

Menu System Adjustments:

- ◆ Picture adjustments—Aspect Ratio: 4:3 format and 16:9 format
- ◆ Picture Shape: Normal, Letterbox, Cropped, Stretch, and Expand
- ◆ Scan Mode: Interlaced and Progressive (for 480i/p televisions)
- ◆ Automatic Channel Search for both tuners (DTV and NTSC)
- ◆ Channel Scan Memory
- ◆ Initial Channel
- ◆ Channel Display Banner (Full and Brief)
- ◆ Auto or Manual Clock setting
- ◆ Digital Audio Output: S/P DIF and PCM
- ◆ Trilingual Menu Options

On-Screen Displays (OSD):

- ◆ Channel Display Banner Information (Full and Brief)
- ◆ Channel Map listing of all channels
- ◆ Closed-Captioning
- ◆ XDS (Extended data service) station call letters, title of show, and rating
- ◆ Audio Modes: DTV—Main and Sub
NTSC—Stereo, Mono, and SAP
- ◆ DTV signal quality to aid antenna orientation
- ◆ V-Guide rating limits: Movies and TV guidelines

Power Requirement:

- ◆ Source: AC 120V, 60Hz
- ◆ Consumption: Approximately 21 Watts

Trademarks Information:

Manufactured under license from Dolby Laboratories. “Dolby” and the double-D symbol are trademarks of Dolby Laboratories.

Contains iType™ font rendering technology from Agfa Monotype Corporation. “The Type software used in this product are under license from Agfa Monotype Corporation and cannot be extracted for any other use.”

 is a federal registered trademark of Zentek Technologies, Inc.

Controls and Indicators:

- ◆ Front Panel Indicators: Power, 480P, DTV, and 4:3
- ◆ Front Panel Keys:

Power	Channel (up-down)	Enter
Menu	Cursor (left-right)	Reset (CPU)
- ◆ Remote Control Keys:

Mode Selection	Power	Display
0~9 number keys	Enter	Caption
Menu	Recall	Audio
Pix Shape	CH Map	Tuner
V-Guide	(-) Sub Channel	
Volume/Cursor (left-right)		
Channel/Cursor (Up/Down)		
Reset (factory settings)		
Auxiliary control keys		

Jacks and Connectors:

- ◆ 1 – NTSC Input F-Connector, 75 ohm
- ◆ 1 – DTV (ATSC) Input F-connector
- ◆ 1 – RF Output F-connector with Ch3–4 switch
- ◆ 2 sets – Audio/Video Outputs (A/V-1, A/V2)
- ◆ 2 – S-Video Outputs (S-1, S-2)
- ◆ 1 – Component Output (Y-Pb-Pr)
- ◆ 1 – Digital Audio Output (Optical S/P DIF or PCM)

Accessories (Included):

- ◆ Multimedia Remote (SDB/TV/VCR/DVD)
- ◆ Coaxial RF Cable
- ◆ Audio Video Cable (phono-type)
- ◆ S-Video Cable
- ◆ Component Cable
- ◆ Quick ‘N Easy Startup Guide

Size and Weight (approximately):

- ◆ Size:

Horizontal Dim. (Width):	13.1 in. (332.7mm)
Vertical Dim. (Height):	2.7 in. (69.1mm)
Depth Dim. (Thickness):	11.0 in. (278.1mm)
- ◆ Weight: 6.46 (lbs), 2.9 (Kg)

This product is subject to continuous improvement, resulting in the design and specifications to change without notice. The weight and dimensions shown are approximate measurements.

Understanding the DIR-2000's Features

Analog and Digital Signals

Analog

Traditionally, televisions have received signals sent (broadcast) over the airwaves or via cable (CATV). These signals included the carrier wave and the picture and sound data. The picture and sound information is superimposed upon a carrier wave by varying the signal frequency and the signal amplitude. This varying signal method is also known as ANALOG. The television tuner selects the channel and decodes these signals and the television uses the decoded data to recreate the picture and sound.

Digital

The SDB receives DTV signals sent through the air as well. However, the digital signals are encoded differently. The digital signal represents the picture and sound information as zeros and ones. Both analog and digital transmissions are limited to six megahertz of bandwidth per channel. However, digital signals are compressed (made to fit in a much smaller space), therefore, more data can be transmitted within the same six megahertz bandwidth. This allows the digital signal to contain data as well as the picture and sound. The digital signal could contain information such as program guides.

Analog and Digital Tuners

The DIR-2000 includes tuners to receive both analog and digital signals. The digital tuner will receive digital channels. The analog tuner can receive VHF channels 2–13 and UHF channels 14–69, or up to 125 cable channels.

Output Signals

The DIR-2000 can output 480i (Interlaced) and 480p (Progressive) component signals. The display device you choose during initial setup determines which signals are available for output.



Figure 1—Output Options

Choosing the Appropriate Connection Method

If you are connecting the Sanyo Digital Box to an Advanced TV or component system, use the SDB Component Video output jacks and the digital audio out or analog audio L/R out on the back of the box.

Otherwise connect your analog TV to the A/V output jacks or to the “Out to TV” RF terminal on the SDB back.

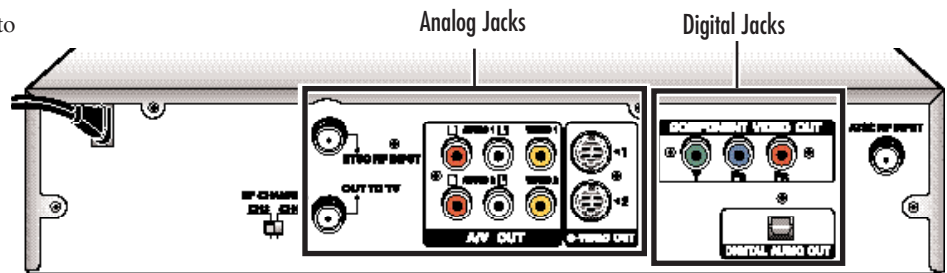

Figure 2—SDB Back Connections

The Main Menu

The Main menu is divided into three categories, Picture, Channel, and Setup. These categories appear as tabs across the top of the display. Each of these categories offers several features and various options for each feature. (The Features are in the left hand column and the options appear in the right hand column.) The available options will vary depending upon the type of signal being received and the type of output device you choose during the initial output device setup (Conventional TV or Advanced TV). (Figure 1.)



Figure 3—Main Menu Categories

Accessing the Main Menu

You access the Main menu by pressing the **MENU** key on the remote control or front panel.

RESET

In the event of a software lockup use a paper clip to reset the SDB.



Figure 4—Menu key locations

Menu Labeling

When a category or option is selected its label will have a yellow highlight. When a feature is selected, not only will its label be highlighted, but it will also “point” to the available options that appear in the right hand column. The active option will have a checkmark (✓) beside its title. (Figure 5.)

Navigating the Menu System

Use the **CURSOR** keys to navigate through the menu Categories, Features, and Options. The  /  cursor keys move the highlight to the left or right. The  /  cursor keys move the highlight up and down. (The Up and Down keys move the highlight in a continuous loop.)

Picture Category, Features, and Options

Aspect Ratio

The aspect ratio of a television picture is the relationship of the width to the height. The standard Analog aspect ratio is 4:3 (pronounced four to three). The 16:9 aspect ratio appears wider, more closely resembling a movie theater screen image.

Pix Shape

The image can be viewed in the following on-screen formats:

- LetterBox – picture image appears with black bars on the top and bottom of the screen.
- Cropped – the picture image right and left sides are cut off.
- Stretch – picture image is horizontally enlarged to fill 16:9 screen
- Expand – 4:3 setting enlarges the picture image proportionally with minimal portion of top and bottom cut-off to fill screen.
16:9 setting enlarges the picture image proportionally to fill screen both vertically and horizontally providing a wide picture format.

These options will depend on the current signal reception and the following Aspect Ratio setting:

Settings	Options Available
4:3 Reception and 4:3 Aspect setting	Normal
4:3 Reception and 16:9 Aspect setting	Normal, Stretch, and Expand
16:9 Reception and 4:3 Aspect setting	LetterBox and Cropped
16:9 Reception and 16:9 Aspect setting	Normal, Stretch, and Expand

Scan Mode

Interlaced

This is the term given to the dual-field method of scanning. Two separate fields of scan lines are created and “interlaced” together to produce a picture.

Progressive

Progressive is the term given to sequentially scanned lines (or non-interlaced). This is the method most commonly used in computer monitors.

NOTE: When receiving an analog signal (NTSC), *Normal* will be the only option available for each of the Picture category features.

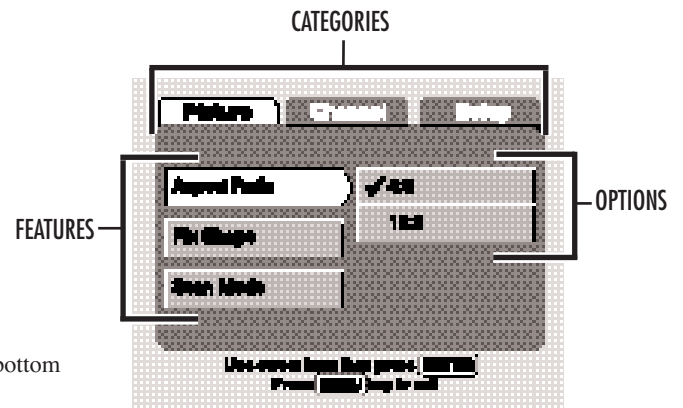

Figure 5—Aspect Ratio

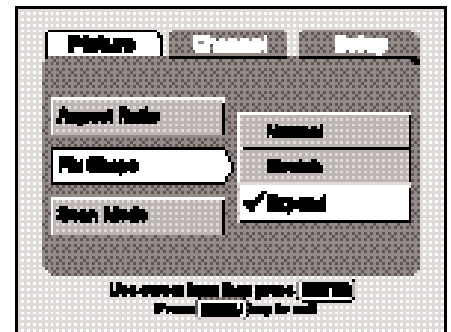

Figure 6—Pix Shape

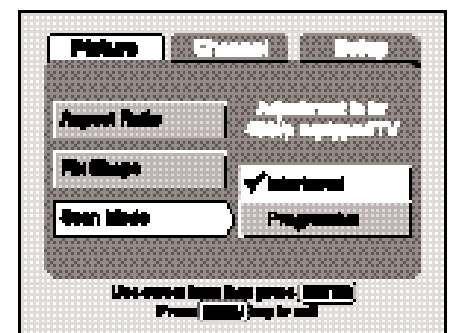

Figure 7—Scan Mode

Understanding the DIR-2000's Features

Channel Category Features and Options

Search

Search is used to find and store in memory all active channels being received. This includes NTSC and Digital DTV channels.

NightScan Search

The NightScan feature automatically searches to keep the database fresh and updated with new DTV channels. This occurs at random intervals during inactive times. Please note that NightScan adds channels to the memory, it does not delete or replace existing channels.

Initial Channel

The SDB can be programmed to tune to a specific channel each time it is powered on, such as your favorite news or sports channel.

Display Banner

The Display Banner appears when you change channels and when you press the **DISPLAY** key. It has two options, Full and Brief. The Full banner may include the station ID, program

picture and sound options. The Brief banner may only include the station ID (with tuner indicator C for Cable [C34], D for Digital [D43-05], or Blank for Off-Air [13]) and time (if the clock has been set).

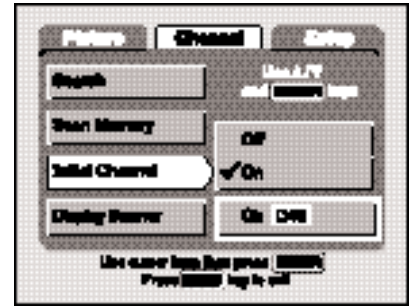

Figure 8—Selecting An Initial Channel

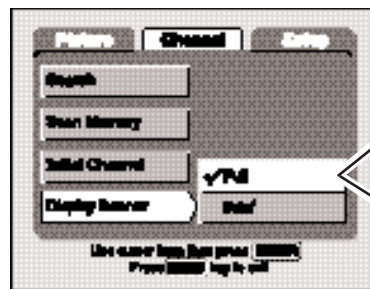

Figure 9—Display Banner Selection



Figure 10—Full DTV Display Banner title, the time, and other TV settings concerning

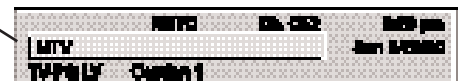

Figure 11—Full NTSC Display Banner

Channel Map Pages

These pages are basically charts of channel numbers. The Channel Map shows the available channels discovered during the last Channel Search. The Map pages also indicate channels which have been deleted from the Channel Scan Memory List, they appear as blue numbers. For DTV, the Channel Map will show only major channel numbers.



Figure 12—Channel Map Page

Setup Category Features and Options

Clock/Day

Use this feature to choose between Auto and Manual clock settings. Choosing Auto will begin the automatic clock setting routine. If you choose Manual you will be directed to input the correct time and day information manually using the 0-9 and Cursor keys on the remote control.

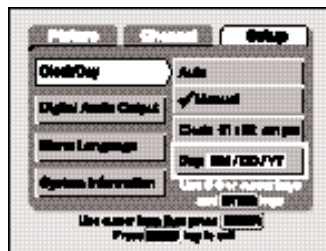

Figure 13—Manual Clock Settings

Menu Language

There are three options available for the menu display language: English, Español, and Français. All menu categories, features, and options will appear in the language you choose. English is the default language.

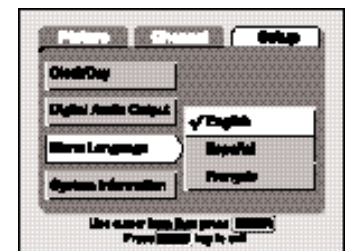

Figure 15—Menu Language

Digital Audio Output

When receiving a digital signal there will be two Audio options, PCM and S/P DIF. PCM will be the only option available when receiving an analog signal.

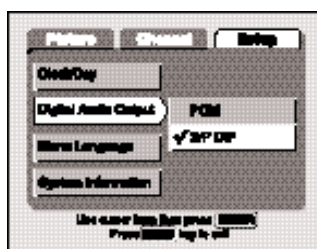

Figure 14—Digital Settings

System Information

The information displayed is for service technician use only.

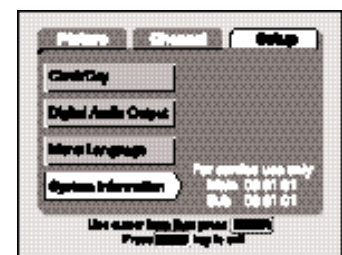

Figure 16—System Information

Using the Remote Control

Use this universal remote to operate your SDB, TV, VCR, and DVD. Refer to the “Quick ‘N Easy” Startup Guide for programming procedure. Since this remote control will operate several pieces of equipment, make sure you press the appropriate key to control that component. For example, to operate your VCR, press the **VCR** key after programming the remote control.

- ① **SDB Mode Key**—Press to select Sanyo Digital Box as the operating mode.
- ② **VCR Mode Key**—Press to select VCR as the operating mode. Must be programmed, refer to “Quick ‘N Easy” Startup Guide.
- ③ **Input Key**—Use this key to switch between TV and Video modes or TV and VCR modes.
- ④ **Number Keys**—Use these keys to directly select channels on your SDB, TV, and VCR. Also use them to set the Clock and Day.
- ⑤ **Channel (CH) Scan Up/Down Keys**—Use the ▲/▼ keys to select next channel up or down on your SDB, TV, and VCR. For DVD operation, use these keys to skip forward or reverse. DTV channels will show only the major channel numbers. These keys have multiple usage; during normal viewing they function as scan keys, within the menu system they function as directional keys. Channel Up/Down Scan keys move highlight in a continuous loop through all available channels: NTSC ↻ DTV. (Same function as item 20, cursor keys.)
- ⑥ **Tuner Key**—Use this key to toggle from one tuning system to another, digital DTV channels and analog NTSC channels (cable and VHF/UHF). This key will only operate the SDB.
- ⑦ (-) **Sub CH (Channel) Key**—This key will only operate the SDB. Use this key to access minor channels numbers.
- ⑧ **Pix shape Key**—Use this key to access the picture shape options: LetterBox, Cropped, Stretch, and Expand. This key will only operate the SDB.
- ⑨ **Menu Key**—Press this key to display the on-screen menu on your SDB and Sanyo Television. This key will not operate your VCR, other brand TV, or DVD player.
- ⑩ **Enter Key**—Press this key when using the SDB menu to choose the selection, channel number entry, and on-screen menu
- ⑪ **Mute Key**—Press this key to instantly turn off the TV sound. Press again to restore the sound to its previous level.

- ⑫ **Caption Key**—Press to select the Closed Captioning modes for your DVD and Sanyo TV only. Captioning is only received through the NTSC analog tuner.

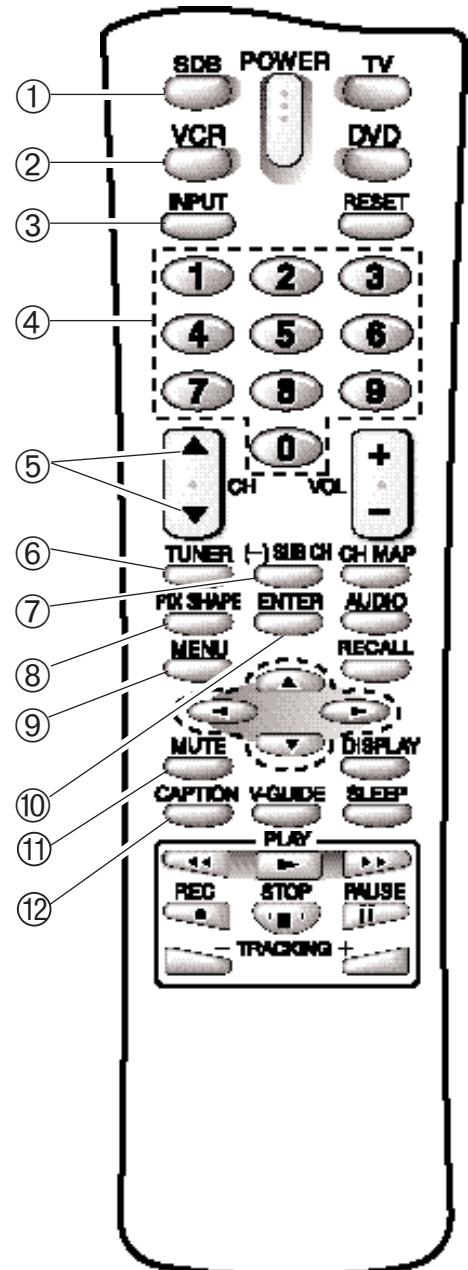

(Continued on page 10.)

Using the Remote Control (Continued)

⑬ **TV Mode Key**—Press to select the operating mode for your TV. Must be programmed. Refer to “Quick ‘N Easy” Startup Guide.

⑭ **DVD Mode Key**—Press to select the operating mode for your DVD. Must be programmed. Refer to “Quick ‘N Easy” Startup Guide.

⑮ **Reset Key**—Press twice to restore all customer adjustable controls to the original factory settings. A display warning will appear. Press again to begin channel search procedure.

⑯ **Volume (VOL) + Up/- Down Keys**—Use the +/- keys to adjust the sound level on your TV.

⑰ **CH (Channel) Map Key**—Press this key to display the channel map page. The map page will display either DTV digital channels or NTSC analog channels (cable or VHF/UHF). Currently selected channel number will be highlighted in yellow. Deleted channels will be blue.

⑱ **Audio Key**—Press to select the desired audio reception feature options (if available) for DTV: Main, Sub-1, Sub-2, Sub-3 etc., or for NTSC: Stereo, Mono, and SAP. This key will only operate the SDB.

⑲ **Recall Key**—Use this key to alternate between two channels. It will select the previous channel on your SDB as well as your TV and VCR. This key functions differently on the DVD, it selects the repeat function.

⑳ **Cursor Keys**—Use these keys to scan channels, as directional arrows to highlight features and options, and to navigate through the menu.

The Cursor Up/Down keys move the cursor up and down within the SDB menu, and selects next channel up and down on the SDB, TV, and VCR. Using the Cursor Up/Down keys in DVD mode activates the next/previous or skip forward/reverse function.

The Cursor Left/Right keys move the cursor left and right within the SDB menu. Use the Cursor Left key to delete or undo any numeric entry. The Left/Right keys operate only the SDB.

㉑ **Display Key**—Use this key to show the full channel and time banner display for the SDB, VCR, and DVD mode. Pressing this key in the TV mode will display the Channel Number.

㉒ **Sleep Key**—Use this key with the “0” key to set the Sleep Timer on a Sanyo TV. It does not function in any other mode.

㉓ **V-Guide Key**—Use to access the parental control restrictions for viewing movies and TV programs. (Reference page 20 for detail operation.)

㉔ **VCR/DVD Keys**—Use these keys to operate your VCR and DVD. Remember the remote control must be programmed first.

Rewind  – Fast rewinds VCR tape, and fast skip reverse for DVD.



Play  – Selects play mode.

Fast Forward  – Fast forward VCR tape, and fast skip forward for DVD.

Record  – Selects recording mode for VCR only.

Stop  – Selects stop mode.



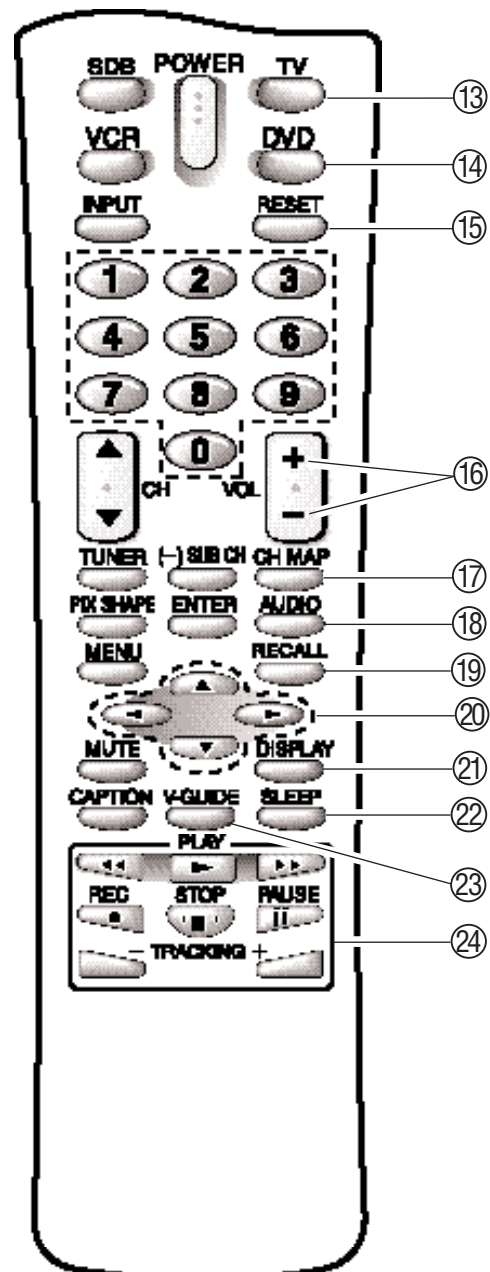

Pause  – Select pause mode.

Tracking  /  – Adjusts VCR head tracking, and still frame step forward or reverse for DVD.











SDB Menu Operation

General Menu Operation





Use the **CURSOR** keys to navigate through the menu Categories, Features, and Options. The  /  cursor keys move the highlight to the left or right. The  /  cursor keys move the highlight up and down. (The Up and Down keys move the highlight in a continuous loop.)

There are three on-screen menu categories: Picture, Channel, and Setup.

Selecting a Category and Feature Option

1. Press the **MENU** key for on-screen display.
2. Use the  /  keys to select a category.
3. Use the  /  keys to view features and options. As each feature is highlighted, available options will appear and a checkmark “✓” will indicate the current setting.
4. Use the  /  keys to highlight the desired feature.
5. Press the  key.
6. Use the  /  keys to highlight the desired option.
7. Press **ENTER** to set or choose the highlighted option.
8. Press **MENU** to exit.

OR

9. Use the  /  keys to move to the category tab area and the  /  keys to select another category.

Operational Tips:

- The Cursor keys are multi-functional keys.
- During numeric entries, the  key will “undo” any number entered (0~9). This allows numbers to be corrected or changed during channel selection or Clock/Day manual settings.

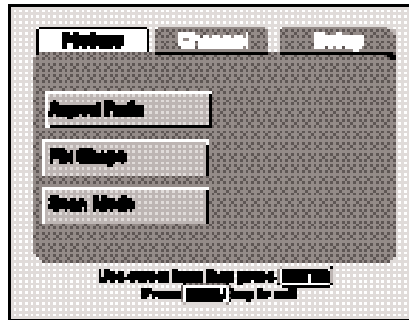

Figure 17—Category (tab highlighted in yellow) with Feature listed

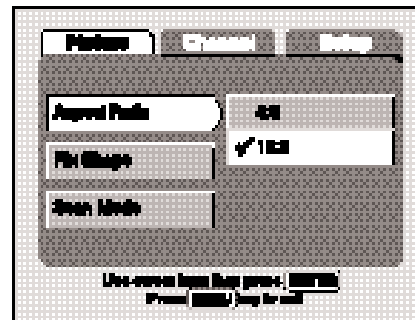

Figure 18—Option selected



QuickTips

- The menu will disappear from the screen after approximately 30 seconds, if no keys are pressed. Press **MENU** key again to redisplay.
- The last adjusted feature is selected when returning to the menu on-screen display.
- Press the remote control **RESET** key to clear all customized settings and return to factory default settings. (SDB starts searching for available channels.)

Need help?

Visit our Web site at
www.sanyoctv.com

SDB Menu Operation—Picture

QuickTips

For Picture Aspect Ratio:

- The 4:3 ratio setting is the NTSC standard.
- The 16:9 ratio setting is a wide-screen picture image.
- Press the remote control **RESET** key to clear all customized settings and return to factory default settings. (SDB starts searching for available channels.)

For Pix (Picture) Shape:







- The **PIX SHAPE** key on the remote operates the same as the **PIX SHAPE** menu selection.
- Using the remote **PIX SHAPE** key allows you to quickly access the Pix Shape feature.
- If Pix Shape did not change the image appearance, make sure you are receiving a digital signal, and the correct feature setting is selected.

Need help?
Visit our Web site at
www.sanyoctv.com

Picture Category

The picture feature allows you to change and adjust the on-screen image by changing the *aspect ratio*, *pix shape*, and *scan mode*. Please note that the adjustable menu options depend on the current tuner, channel selection (DTV or NTSC), and signal reception.

Selecting the Picture Aspect Ratio (Width to Height) for DTV Channels

1. Press **MENU** key for on-screen display.
2. Use the  /  keys to select the **Picture** Category.
3. Use the  /  keys to highlight the **Aspect Ratio** feature.
4. Press the  key.
5. Use the  /  keys to select the desired option: 4:3 or 16:9. Press **ENTER**.

NOTE: Normal is the *only* option available for NTSC channels.

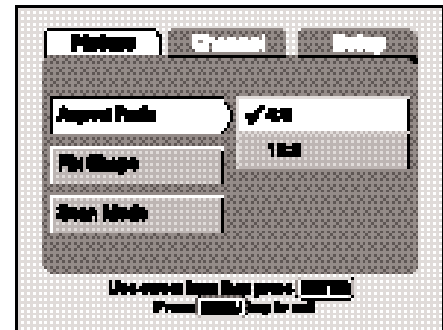







Figure 19—Aspect Ratio

Selecting the Pix (Picture) Shape for DTV Channels

1. Use the  /  keys to highlight the **Pix Shape** feature.
2. Press the  key.
3. Use the  /  keys to select the desired option: LetterBox, Cropped, Stretch, or Expand. Press the **ENTER** key.

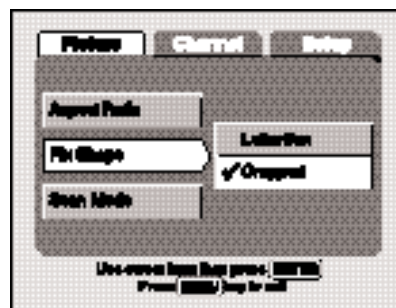

Figure 20—Letterbox Setting
(16:9 Reception & 4:3 Aspect Ratio)

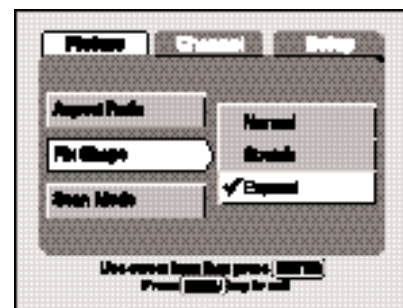







Figure 21—Expand Setting
(4:3 Reception & 16:9 Aspect Ratio)
(16:9 Reception & 16:9 Aspect Ratio)

Selecting the Scan Mode for DTV Channels

The SDB scan feature is designed to automatically adjust your TV's picture image depending on the signal received and tuner selected. For conventional TV the scan mode should be set to interlaced. For advanced television, the scan mode can be set to either interlaced or progressive. In order to received the best quality picture, match your settings with your equipment (DTV-advanced [digital] or NTSC-conventional [analog]).

1. Use the  /  keys to highlight the **Scan Mode** feature.
2. Press the  key.
3. Use the  /  keys to highlight the appropriate option: Interlaced or Progressive. Press the **ENTER** key.

NOTE: Normal is the only option available for NTSC channels.

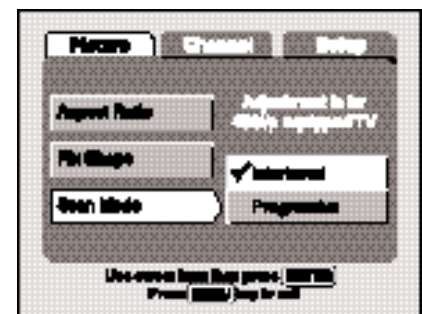

Figure 22—Scan Mode selection

SDB Menu Operation—Channel

Channel Category

Use this feature to automatically search and scan for available channels including NTSC and DTV channels. The Channel Category adjustable features are: Search, Scan Memory, Initial Channel, and Display Banner.

Starting Channel Search

NOTE: An initial search occurs during the first time setup procedure. Running a manual search should be necessary only when you want to search for channels that may have been added or to recover channels you deleted using the Scan Memory feature.

1. Press **MENU** key for on-screen display.
2. Use the / keys to select the **Channel** Category.
3. Use the / keys to highlight the **Search** feature.
4. Press the key.
5. Use the / keys to highlight Start.
6. Press **ENTER** to start channel search. The SDB will automatically start searching for available Digital DTV and NTSC (analog) channels. The NTSC signal search includes Cable and VHF/UHF channels.

NOTES:

- The on-screen message will appear with arrows displayed across the bottom of the screen (to indicate activity) as the search process continues. (See Figure 24.) This may take some time, so please be patient.
- During the Channel Search procedure, only the **POWER** key is operable.

Channel Scan Memory

Channel scan memory is a list of active channels that you can scan through when using the CHannel Scan (up/down) keys. The scan process will select only major channels. This list can be customized by deleting unwanted channels. The Channel Map pages will reflect any changes made to the Channel Memory Scan List.

1. Use the / keys to highlight the **Scan Memory** feature.
2. Use the key to move to the channel number selection area (highlighted). The current channel number will appear. DTV channels will show only the major channel number.
3. Use the / keys to select the unwanted channel.
For example, Ch D35.
4. Press Enter to remove the channel.
5. To delete other channels, repeat steps 3 and 4 above.

Operational Tip:

Press the CH Map key on the remote to view a complete listing of the active channels. “Deleted” channel numbers will be blue. (See page 16 for more detailed information on CH Map usage.)

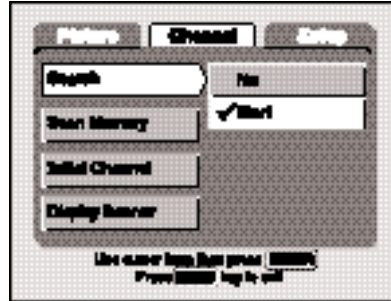

Figure 23—Channel Search



Figure 24—SDB searching for active channels

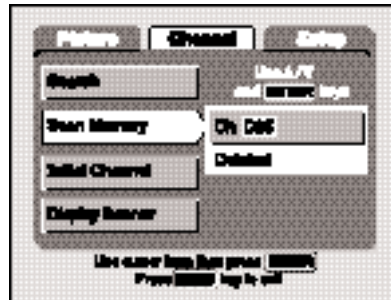

Figure 25—Deleting channels



Figure 26—Channel Map with deleted channels (blue numbers)



QuickTips

- Some features and options may not be available at all times depending on your current signal reception, tuner, and channel selection.
- If you cannot scan some channels, check the CH map page and restart channel search operation or press the remote control RESET key to rescan active channels.
- Channel Up/down Scan keys move highlight in a continuous loop.



- When the remote Channel (up/down) keys are pressed repeatedly faster than the video can be processed, the screen will change to a solid blue color with only a display of the channel number.

Need help?

Visit our Web site at
www.sanyoctv.com

SDB Menu Operation—Channel

QuickTips

- When Initial Channel is set to OFF the SDB will tune to the last channel selected when powered on.
- Each time the channel is changed or selected, the banner information display will appear on screen.
- Use the DISPLAY key to switch the Banner on/off.

Initial Channel

The SDB can be programmed to tune to your favorite channel each time it is powered on, such as your favorite news or sports channel.

1. Use the / keys to highlight the **Initial Channel** feature.
2. Press the key.
3. Use the / keys to highlight On. Press the **ENTER** key.
4. Use the / keys to select desired digital or analog channel. For example, Digital Channel 43.

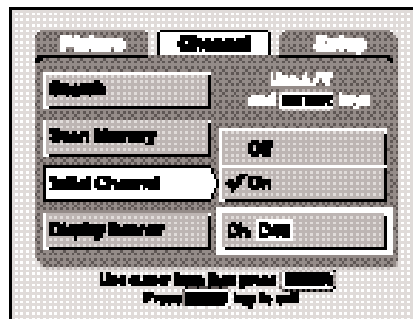

Figure 27—Initial Channel selected

Display Banner

The Banner information will depend on the current tuner, channel selection (DTV or NTSC), and current signal reception.

1. Use the / keys to highlight the **Display Banner** feature.
2. Press the key.
3. Use the / keys to highlight setting: Full or Brief. Press the **ENTER** key.

NOTES:

- When the Display key is pressed, the Full banner will appear regardless of the menu selection and remain on the screen until the Display key is pressed again.
- Captions will not be displayed while the Full banner is on the screen.

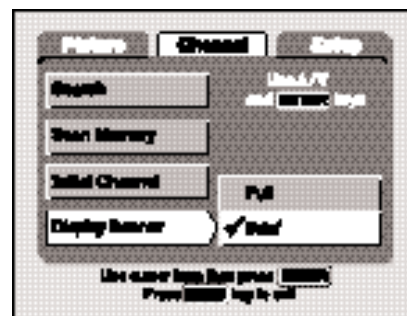

Figure 28—Display Banner

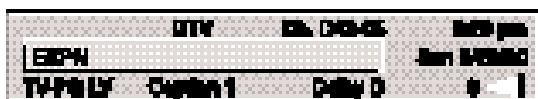

Figure 29—DTV FULL Banner Display



Figure 30—NTSC Full Banner Display

Banner Information:

DTV Full Banner includes:

- Station ID number (if available)
- “DTV” digital channel icon
- Major-Minor channel number and tuner indicator “D”
- Clock time (if set)
- Day date (if set)
- Program Title (if available)
- Program Rating (if available)
- Caption Setting (if set)
- “Dolby D” indicator (if digital signal is received)
- Signal quality with meter

DTV Brief Banner includes:

- Station ID number (if available)
- Major-Minor channel number and tuner indicator “D”
- Clock time (if set)

NTSC Full Banner includes:

- Station ID number (if available)
- “NTSC” analog channel icon
- Channel Number with tuner indicator “C” (cable channels)
- Clock time (if set)
- Day date (if set)
- Program Title (if available)
- Program Rating (if available)
- Caption Setting (if set)

NTSC Brief Banner includes:

- Station ID number (if available)
- Channel Number with tuner indicator “C” (cable channels)
- Clock time (if set)

Need help?

Visit our Web site at
www.sanyoctv.com

SDB Menu Operation—Setup

Use the setup category to set the Clock/Day, Digital Audio Output, and Menu Language features. (No settings required for System Information.) The menu setup feature and options listing will depend on the current tuner/channel selection (DTV or NTSC) and current signal reception.

To set the Clock/Day manually

1. Press **MENU** key for on-screen display.
2. Use the / keys to select the **Setup** category.
3. Use the / keys to highlight the **Clock/Day** feature.
4. Press the key.
5. Use the / keys to highlight **Manual**. The on-screen Clock/Day entry areas appear. Press **ENTER**.
6. Use the remote **0~9** number keys or / keys to enter the proper clock time.
7. Use the / keys to highlight AM or PM.
8. Press **ENTER** to set the time and move the cursor to the **Day** Setting entry area.
9. Use the remote **0~9** number keys or / keys to select the proper day/date. Then press the **ENTER** key.

Operational Tips:

- Use the left key to clear any incorrect number entry.
- The clock must be set before setting the day/date.

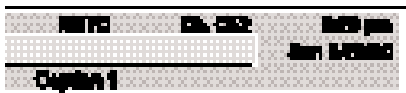

Figure 34—Banner display with Clock Time/Day Settings

Digital Audio Output

Use this feature to choose the format of the digital DTV audio output signal: PCM or S/P DIF.

1. Use the / keys to highlight the **Digital Audio Output** feature.
2. Press the key.
3. Use the / keys to highlight option: PCM or S/P DIF. Press the **ENTER** key.

NOTE: If you are watching an NTSC (analog) channel, “PCM” will be the only option shown.



Figure 31—Setup Category

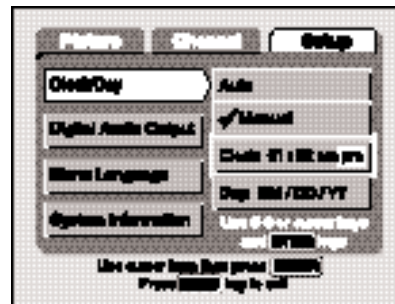

Figure 32—Clock Time

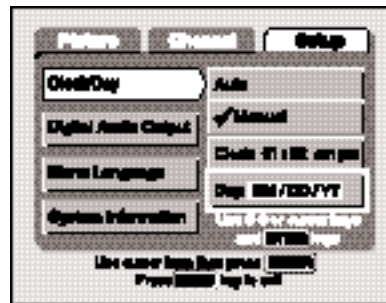

Figure 33—Day [month/day/year]

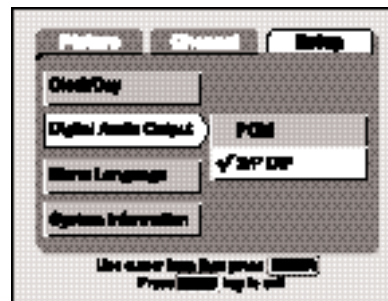

Figure 35—Digital Audio Output



QuickTips

- To see the time of day and date, press the **DISPLAY** key, the banner information will appear on screen.
- The Channel Banner (Full or Brief) Clock display will be blank if the clock/day has not been set.
- To use the Auto Clock/Day feature, a local PBS station that is broadcasting an extended data service (XDS) signal must be received. The Auto Clock/Day searches for the transmitted signal and automatically sets the Clock/Day.
- If no NTSC channel signals are found during the channel search process, the SDB will automatically skip the Automatic Clock/Day Setup process.
- During the Clock/Day setup procedure, only the **POWER** and **DISPLAY** keys are operational.

Need help?

Visit our Web site at
www.sanyoctv.com

SDB Menu Operation—Picture

QuickTips





- If you don't recognize words in the on-screen menu, change the menu option language or press the remote control **RESET** key twice (personalized settings will be reset to factory defaults).

- The **CH MAP** remote key will only operate the Sanyo Digital Box.

Need help?
Visit our Web site at
www.sanyoctv.com

Selecting the Menu Language

All menu Categories, Features, and Options will appear in the language you choose. English is the default language.

1. Use the  /  keys to highlight the **Menu Language** feature.
2. Press the right  key.
3. Use the  /  keys to highlight a language option: English, Español, or Français. Press the **ENTER** key.

NOTE: The menu language does not affect the Captioning text language.

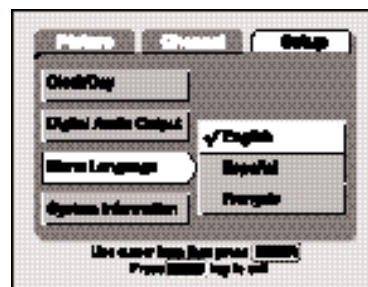

Figure 36—Menu Language

System Information

This feature is designed for use by the factory and/or service personnel. The display is for diagnostic purposes only, there are no customer adjustments.

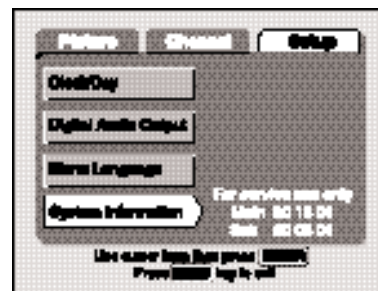

Figure 37—System Information

Channel Map

The SDB automatically displays the CHannel Map in columns regardless of the total number of channels. Rows will vary based on the number of channels received. If the CHannel Map page is longer than the screen display, simply use the cursor keys to scroll as needed. Also, this feature can be used as an express selection process to access channel numbers, see page 17.

The SDB Channel NightScan feature searches for new channels and adds them to the channel database. This operation will be performed at random intervals during in-active times. This feature automatically updates only DTV channels.



The CHannel Map display depends on the following conditions:

- If channel signals are not detected, the Map page for that category (DTV or NTSC) will be blank.
- The NTSC CHannel Map page will display either CATV channels or Off-Air channels but not both. During channel search, the SDB will scan both types. The SDB will automatically detect the proper type to be displayed and used for the NTSC database (for a maximum of 125 cable channels or a maximum of 68 VHF/UHF channels [VHF 2-13, UHF 14-69]). (NTSC channels depend on the type of signal connected to the NTSC RF input.)
- When the CHannel Map is displayed on the screen, you can press the **TUNER** key to switch between the categories.
- DTV channels will show only the major channel number.



Figure 39—DTV CH Map

Using the Channel Map

1. Press the **CH MAP** key on the remote control once to display the *CHannel Map* page(s).
2. Use the /  keys to highlight the desired category: DTV or NTSC.
3. Press the **CH MAP** key to exit.



NOTE: Deleted channels will be blue. The current channel will have a yellow background.



Figure 40—NTSC CH Map

Express Channel Selection

To quickly select a channel within the CHannel Map page:

1. Press the **CH MAP** key on the remote control.
2. Use the /  keys to highlight the desired category: DTV or NTSC.
3. Use the **CURSOR** keys to highlight the desired channel. For example, Channel 52. Press the **ENTER** key. (See Figure 42.)

To quickly switch between a DTV and NTSC channel:

1. Press the **TUNER** key repeatedly until the desired tuning system channel number display appears on the screen.
2. Select an NTSC cable channel by entering the channel number. For cable channels above 100 press and hold the **1** key for about two seconds (until **1--** appears). Then enter the other two digits.
OR
3. Select a DTV channel by entering the major and minor numbers of the channel as follows: **4, 3, (-) Sub, 0**, and **5** for channel “D43-05.”

NOTES:

- The CHannel Map shows all available channels and reflects the current status of channels within the CHannel Scan Memory. All deleted channels will appear blue.
- The tuner channel (DTV and NTSC) categories:
DTV (digital) channels with only major channel numbers listed.
NTSC (analog) channels with Cable channels 01~125 or VHF/UHF channels 02-69.
- Entering 00 for the minor channel number will cause the SDB to tune to the NTSC channel matching the major channel number.

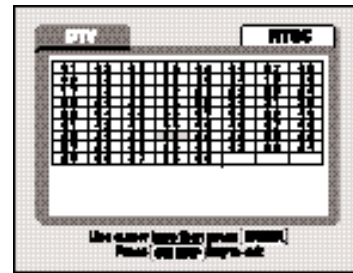

Figure 41—Channel Map of NTSC channels display



Figure 42—NTSC Channel C52, selected



QuickTips

- Pressing the **CH Map** remote key will display a blank page with category tabs only, if channel signals are not detected.
- When the **CHannel Map** page is active, only the **Power**, **CH Map**, **Tuner**, **Enter** and **Cursor** keys are operational.
- When the **CHannel Map** page is active, the **TUNER** key will switch between the tuning systems (DTV and NTSC).

Need help?

Visit our Web site at
www.sanyoctv.com

(-) Sub CHannel Selection

QuickTips

- Changing a channel within the same tuner system, simply enter the channel number. For example DTV-to-DTV or NTSC-to-NTSC.

Direct Channel Selection

The 0-9 Number keys are used to select channels directly within the Brief Channel Number Display entry area. DTV or NTSC channels 01 through 09 can be entered using one or two digits. To enter one hundred digit, press and hold the “1” key for about two seconds, if cable channels are available, 1-- will appear. Then enter the other two digits.

To select a direct channel:

1. Press any numeric key (0-9), the Brief Channel Number Display will appear on the screen.
2. Enter a channel number. After three seconds the channel will be selected, or press the **ENTER** key to instantly select the channel.

NOTE: During number entry, use the left  key to undo an entry.

The following conditions of selecting a direct channel will occur.

- If you select a nonexistent DTV channel or a very weak NTSC channel, see figure 43.
- If you select a valid DTV channel that is currently broadcasting no video signal or no audio signals, see figure 44.
- If you select a valid DTV channel that is broadcasting an audio signal, but no video signal, see figure 45.
- If you incorrectly connect a DVD player or VCR to the NTSC RF Input (on back of SDB) and then try to watch a copyrighted program, disc, or tape. A copyright protection signal is detected which triggers the SDB to display an error message, see figure 46.

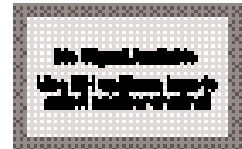

Figure 43



Figure 44

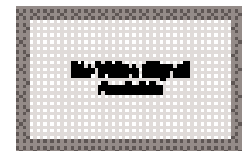

Figure 45



Figure 46

(-) Sub CHannel Selection

The (-) Sub CHannel key on the remote control can be used as a direct channel selection process for DTV channels. Any time the (-) Sub CHannel key is pressed, the DTV tuning system is automatically selected. Use this key to select major and minor channels. After a major channel is entered, the (-) Sub CHannel key is used to provide access to the minor channels.

Using the (-) Sub CHannel key to select a channel

1. Press the (-) **SUB CH** key, the major channel number for the current program will appear with a list of up to three available minor (sub) channels. (The selected minor channel will appear with a yellow arrow indicator.)
2. While the Sub-Channel Display is on the screen, select the minor channel using the Channel (up/down keys). If more than three minor sub-channels are available, scroll up or down the list to locate channel.
3. Press **ENTER** to instantly select the minor channel or just wait for three seconds and the SDB will automatically select the minor channel.

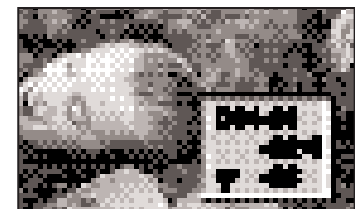

Figure 47—Major Channel with Minor Channel 02, selected

NOTES:

- If no keys are pressed after five (5) seconds, the Sub-Channel display will disappear from the screen.
- While the Sub-Channel display is on the screen, only the **POWER**, **ENTER**, and **CHANNEL SCAN** keys are operable.

Need help?

Visit our Web site at
www.sanyoctv.com

Selecting a Major or Minor Channel using the (-) Sub CHannel Key

1. DTV Channels may be selected by entering only the major number. If a DTV minor channel is not entered after pressing the (-) Sub CHannel key, the SDB will automatically select the lowest minor channel, -01 or -1 for the DTV major channel entered. For example, if D34-__ is entered, the SDB will tune to DTV Channel 34-01.
2. If any DTV minor channel number is entered as -00 or -0, the SDB will tune to the NTSC channel matching the major channel number. For example, if D24-00 is entered, the SDB will tune to Cable C24 or (UHF channel 24).
3. To select a major channel with a specific minor sub-channel: enter the major number, press (-) **SUB CH** key, and then enter the minor channel number.
4. Press **ENTER** to instantly select the minor channel or just wait for three seconds and the SDB will automatically select the minor channel.

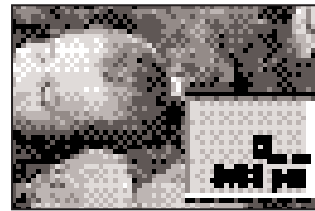

Figure 48—Channel Entry for Major Channel

Operational Tips:

- If you are watching an NTSC channel and decide to change to a DTV channel. Simply press the (-) **SUB CH** key, the DTV channel number entry (D__) display will appear. Enter the channel number. Then press **ENTER** to instantly select the minor channel or just wait for three seconds and the SDB will automatically select the minor channel.
- If watching a DTV channel with the banner displayed on the screen, and you press the (-) **SUB CH** key, the SDB will automatically remove the full banner (see Figure 49). The Brief Channel display will appear with sub channels listed (see Figure 50).
- If watching an NTSC channel with the banner displayed on the screen, and you press the (-) **SUB CH** key, the SDB will automatically change the channel number entry area (D__) in the full banner display. A digital channel number may be entered.

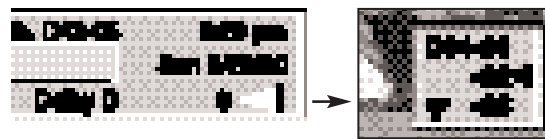

Figure 49

Figure 50

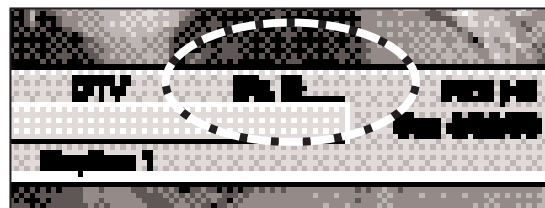

Figure 51—Channel entry area (circled)

Audio Reception

Audio options will depend on the channel tuning system selected and the current broadcaster's signal received. The audio mode will display on screen for each selected choice, if available.

1. Press the **AUDIO** key, current setting will appear on screen.
2. To change setting, press the **AUDIO** key repeatedly until the desired option appears.

DTV options: Main, Sub-1, Sub-2, Sub-3, ...

NTSC options: Stereo, Mono, SAP

For DTV—Main.

For NTSC—Stereo.

3. Press **ENTER** to instantly select the option.

NOTES:

- If audio selection is not available, the Audio mode will change to the SDB default modes.
- If you select SAP while watching an NTSC channel, the SDB will remain in the SAP audio mode until another option is selected. If SAP is not available, the audio mode defaults to Stereo.
- If you select Sub-1 while watching a DTV channel, the SDB will remain in the Sub-1 audio mode until another option is selected. If Sub-1 is not available, the audio mode defaults to Main.

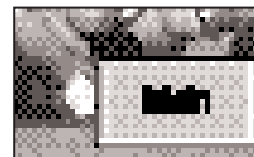

Figure 52—DTV Option: Main

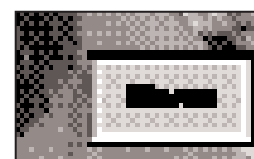

Figure 53—NTSC Option: Stereo



QuickTips

- Major channels can be selected from the CH Map page.
- Minor channels can be selected only when the (-) Sub CHannel key is pressed; then the Major channels appears with a list of available minor channels.
- If the RF out jack is used, the signal will be monaural.
- Stereo is not available through RF out; only through A/V connections.

Need help?

Visit our Web site at

www.sanyoctv.com

QuickTips

- Press the **V-Guide**; then press the **DISPLAY** key to temporarily override the restriction settings and instantly return to normal viewing.
- V-Guide restrictions will be restored when power is reapplied.

The V-Guide feature is used to access the parental control restrictions. This Sanyo Digital Box is equipped with a V-Chip that can be programmed to block shows with content you deem as inappropriate for your children to view. There are three guidelines to choose: Movies, TV Age, and TV Content. Each category is blocked as rating information is received and decoded. The V-Guide blocked rating restricts the viewing of Digital and NTSC channels.

BLOCKING MOVIES

1. Press **V-GUIDE** key on the remote control once, the entry page of the V-Guide (parental control) setup OSD will appear.
2. Press the **ENTER** key to proceed to the main option selection page.
3. Use the **←**/**→** keys to choose **Movies**.
4. Use the **▲**/**▼** keys to highlight your choice, (such as, R).
5. Press **ENTER** key to switch between the Blocked and Unblocked option rating.

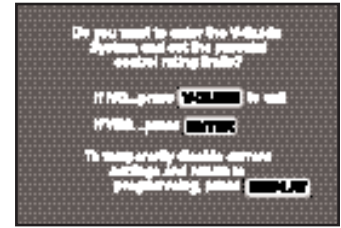

Figure 54—V-Guide

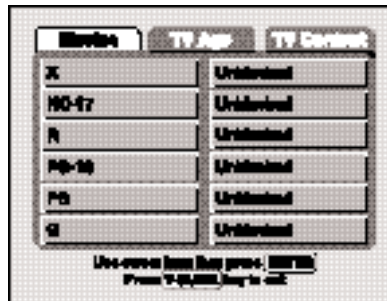

Figure 55—V-Guide Main Option Display



Figure 56—Movie Rating R, blocked

NOTES—As a Rating Limit is selected:

- Block action will block all higher rated limits. For example, Setting the limit to Block an “R” rating automatically blocks the ratings NC-17 and X.
- Unblock action will unlock all lower rated limits. For example, Setting the limit to Unblock a “PG-13” rating automatically unblocks the ratings “PG” and “G.”
- For complete V-Chip operation and function capabilities, please refer to EIA-744A Standard (U.S. requirements only) on Web site <http://www.tvguidelines.org>.

BLOCKING TV PROGRAMS

TV Age Based

1. Press **V-GUIDE** key.
2. Press the **ENTER** key to proceed to the main option selection page.
3. Use the **←**/**→** keys to choose **TV Age**.
4. Use the **▲**/**▼** keys to highlight your choice, (such as, TV-PG).
5. Press **ENTER** key to switch between the Blocked and Unblocked rating option.

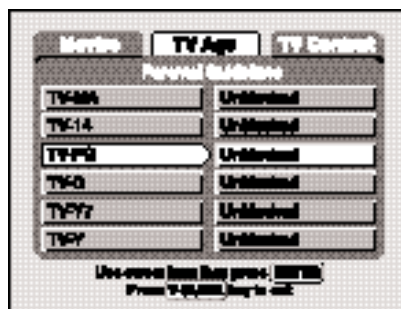

Figure 57—TV Age, TVPG rating

TV Content Based

1. Press **V-GUIDE** key.
2. Press the **ENTER** key to proceed to the main option selection page.
3. Use the **←**/**→** keys to choose **TV Content**.
4. Use the **▲**/**▼** keys to highlight a content option, (such as, D-Suggestive Dialog).
5. Use the **←**/**→** then **▲**/**▼** keys to highlight your choice (such as, TV14).
6. Press **ENTER** key to switch between the Blocked and Unblocked rating option.
7. Use the **←** key to select another category. Repeat steps above.

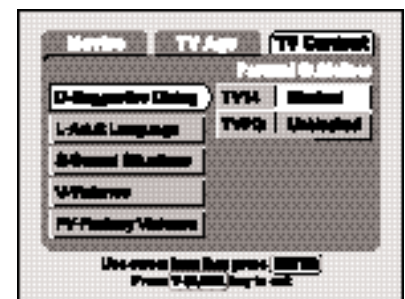
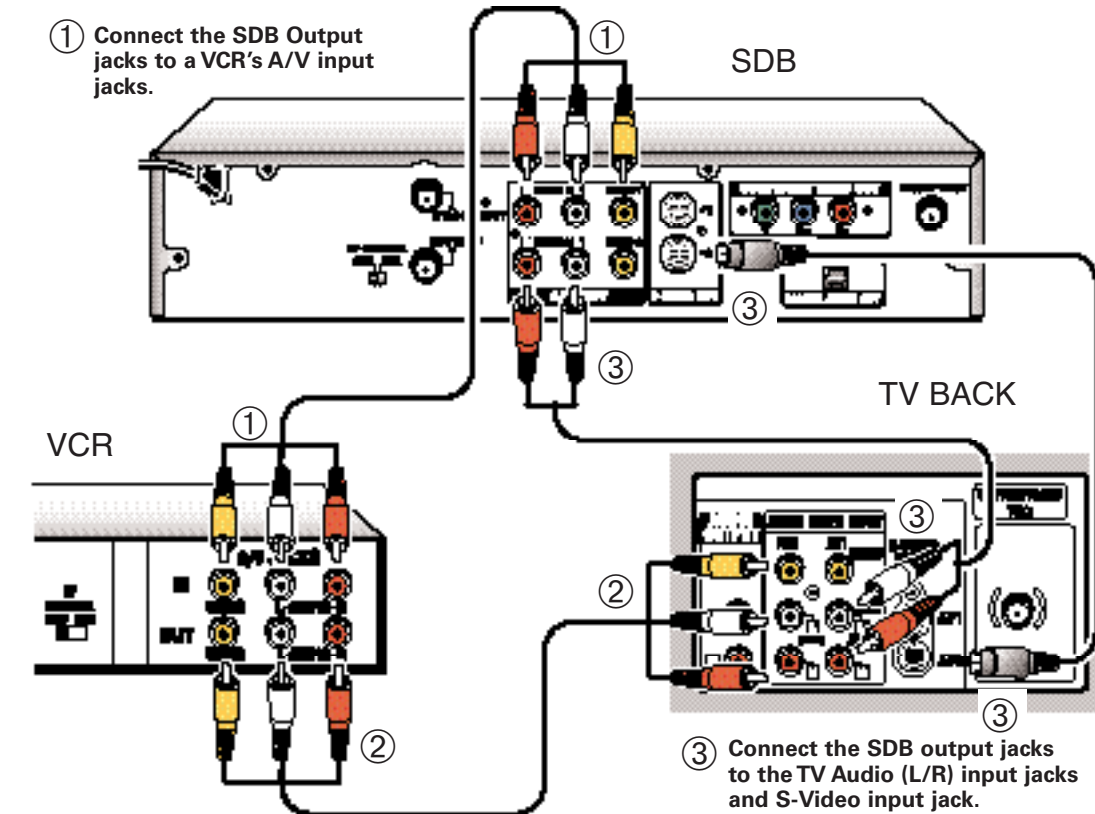

Figure 58—TV Content, D-Suggestive Dialog TV14, blocked

Need help?

Visit our Web site at
www.sanyoctv.com

SDB Output Jacks Connection



QuickTips

- A/V1 and A/V2 jacks have identical functions. Any compatible video equipment can be connect to either set of jacks.
- Make sure all cable connectors are fully seated on jacks.
- Always match cables according to the colors on the jacks.

Need help?
 Visit our Web site at www.sanyoctv.com

- NOTES:
- For input and digital output connections, refer to the “Quick ‘N Easy” Startup Guide Connecting Diagrams.
 - DO NOT connect VCR/DVD RF output to the RF Input of the SDB. (See page 18, figure 46.)

Resetting the SDB

Use this feature to return all customer adjustable controls to the original factory settings.

1. Press **RESET** key on the remote control once, the on-screen message appears.
2. Press **RESET** key again to cancel all customized settings and return to factory settings.

NOTE: The SDB will return to the Initial power on procedures: Channel Search, Monitor Type Selection, and Auto Clock/Day Setup process.

Factory Default Settings

Channel Search	Reset with initial setup procedures
Monitor Type Selection . . .	Reset with initial setup procedures
Clock/Day	Reset with initial setup procedures
Aspect Ratio	4:3
Pix Shape	NTSC-Normal, DTV-Normal (for 4:3 Reception, 16:9 Reception and 16:9 Aspect), LetterBox (for 16:9 Reception and 4:3 Aspect)
Scan Mode	Interlaced (480i)
CH Scan Memory	Reset with initial channel search
Initial Channel	Off
Display Banner	Brief
Audio Reception	NTSC-Stereo, DTV-Main
Digital Audio Out	S/P DIF
Menu Language	English
Caption	Off
V-Guide	Off with all settings/rating limits cleared

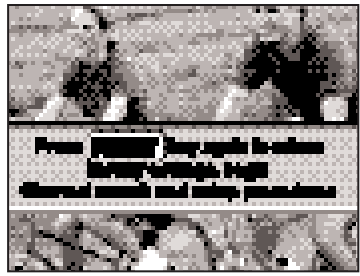

Figure 59—Reset the SDB



Figure 60—Resetting the SDB to factory default settings

Closed-Captioning

QuickTips

- If Caption Text mode is selected and no captioned text is broadcasted, a black box may appear and remain on the TV screen.



To remove this black box, set captioning to any mode other than Text 1 or Text 2 or press the **RESET** key to cancel captioning and customized settings.

Need help?

Visit our Web site at
www.sanyoctv.com

Captioning is text transmitted along with the picture and sound so it can be displayed on the screen. Captioning will depend on the channel tuning system selected and the current broadcaster's signal received. Closed-Captioning is received only through the NTSC tuner.

Selecting Captioning:

Press **CAPTION** key to select desired options:

→ Caption OFF → Caption 1 →Caption 2 →Text 1 →Text 2

Local broadcasters decide which caption signals to transmit. They may not choose to provide captions or may provide captions in one or all of the available modes.

Caption 1: This is the main mode used for program captioning (words match the program you are watching). Almost all broadcasters will use Caption 1 to transmit program captions. These captions are generally one or two lines.

Caption 2: This is an alternative mode for program captioning. Caption 2 may be used by the broadcaster to provide captions in another language, such as, Spanish or French.

Text 1: This mode is used to display large amounts of text. This text will appear within a black box that may be nearly as large as the TV screen. Text displayed in this manner does not generally relate to the program. These captions may be used by broadcasters to provide weather reports, community bulletins, stock quotes, etc.

Text 2: This mode is an alternative mode used to display large amounts of text. The same types of information displayed in Text 1 can be displayed in Text 2.

NOTE: This SDB provides standard analog closed-captioning displays.

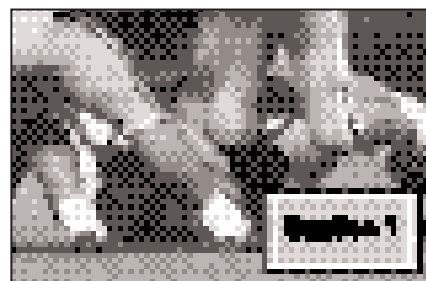

Figure 61—Caption 1 Mode



Figure 62—Caption 1

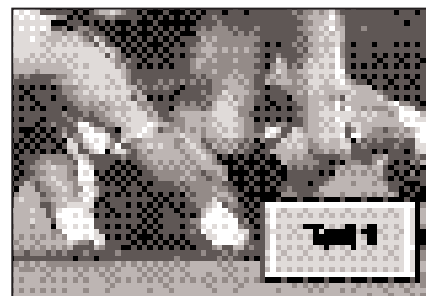

Figure 63—Text 1 Mode

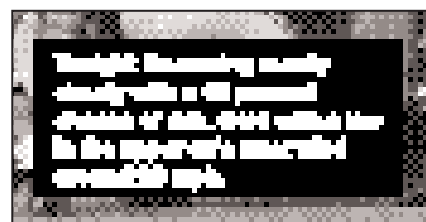

Figure 64—Text 1

Care and Cleaning

The surface of the cabinet can be damaged if not properly maintained. Many common household aerosol sprays, cleaning agents, solvents, and polishes will cause permanent damage to the fine surface.

1. Unplug the power cord before cleaning.
2. Use a dry cloth for cleaning.

Troubleshooting

Before calling for assistance, please look for the condition that most closely resembles your problem in the following charts, then follow the instructions for that condition. Visit our web site at www.sanyoctv.com or call toll free 1-800-877-5032.

No Picture or No sound

- └ Press the Volume key and Change Channels. — Is picture and sound ok?
 - └ Yes. Maybe a blank channel (signal not being transmitting or weak) was selected.
 - └ No. — Check to be sure all your equipment is properly connected, turned on, tuned to channel 3 or 4 (VCR or TV), and correct mode selected.

Poor stereo reception

- └ Press AUDIO key. — Is the quality sound better?
 - └ Yes. Problem is with program or weak signal (station, cable, or satellite reception).
 - └ No. — Change channels.

Screen is solid blue

- └ Press the Channel Up/Down key once. — Did the Blue Screen disappear?
 - └ Yes. Normal operating conditions. You are changing channels faster than the video can be processed.
 - └ No. — Signal might be too weak to be received. Try installing an outdoor antenna or repositioning existing antenna.

Cannot select or scan some channels

- └ Press the RESET key twice (personalized settings will be reset to factory defaults). — Did the problem go away?
 - └ Yes. It may have been the channel scan memory or V-Guide settings.

Blank Channel Map Page

- └ Start Channel Search. — Is the channel map page still blank?
 - └ Yes. Problem could be NO ATSC or NTSC signal received during channel search process.
 - └ No. — Press CHannel Map to select Map page. Channels will be available only if the transmitted signals were detected.

My remote control will not operate my SDB or other equipment

- └ Press the SDB or other mode keys on the Remote Control. Then try it again. Be sure to point the remote control at the equipment. — Does the remote control work now?
 - └ Yes. Another mode was selected. Press the appropriate key to operate the different types of equipment. (Remote must be programmed. Refer to Quick 'N Easy.)
 - └ No. — Replace the batteries or confirm that they are properly installed.

Index

- | | | |
|---------------------------------|---------------------------------|--|
| Analog tuner, 6 | Closed captioning, 9, 22 | NightScan, 4, 8 |
| Antenna, refer to Quick 'N Easy | Digital audio output, 8, 15 | Output Jacks, 6 |
| Aspect ratio, 4, 7, 12 | Digital tuner, 6 | Picture adjustment, 12 |
| Audio reception, 19 | Direct channel selection, 4, 18 | Pix shape, 7, 9, 12 |
| A/V jacks, 21 | Express channel, 17 | Remote control, 9, 10 |
| Brief banner, 4, 8, 14 | Full banner, 8, 14, 19 | Remote programming, refer to Quick 'N Easy |
| Category tabs, 4 | Initial channel, 4, 8, 14, 21 | Resetting the SDB, 21 |
| Channel map, 8, 10, 13, 16, 17 | Major channel, 14, 17, 18, 19 | Scan mode, 7, 12 |
| Channel scanning, 4, 13, 17, 18 | Menu language, 8, 16 | Sub channel, 18, 19 |
| Channel search, 4, 10, 13 | Minor Channel, 14, 17, 18, 19 | TV ratings, 20 |
| Channel selection, 9, 17, 18 | Movie rating, 20 | V-Guide (Parental Control), 20 |
| Clock/day setup, 8, 15 | | |

SANYO Digital Box Limited Warranty

OBLIGATIONS

In order to obtain warranty service, the product must be delivered to and picked up at the user's expense, unless specifically stated otherwise in this warranty.

For customer assistance please visit www.sanyoctv.com or call toll free 1-800-877-5032.

THIS WARRANTY IS VALID ONLY ON SANYO PRODUCTS PURCHASED AND USED IN THE UNITED STATES OF AMERICA, EXCLUDING ALL U.S. TERRITORIES AND PROTECTORATES. THIS WARRANTY APPLIES ONLY TO THE ORIGINAL RETAIL USER, AND DOES NOT APPLY TO PRODUCTS USED FOR ANY INDUSTRIAL, PROFESSIONAL OR COMMERCIAL PURPOSE. THE ORIGINAL DATED BILL OF SALE OR SALES SLIP MUST BE SUBMITTED AT THE TIME WARRANTY SERVICE IS REQUESTED.

Subject to the OBLIGATIONS above and the EXCLUSIONS below, SANYO MANUFACTURING CORPORATION (SMC) warrants this SANYO product against defects in materials and workmanship for the periods specified below. SMC will repair or replace (at its option) the product and any of its parts which fail to conform to this warranty. The warranty period commences on the date the product was first purchased at retail.

UNIT EXCHANGE	PARTS
90 DAYS	1 YEAR

EXCLUSIONS

This warranty does not cover (A) the adjustment of customer-operated controls as explained in the appropriate model's instruction manual, or (B) the repair of any product whose serial number has been altered, defaced or removed.

This warranty shall not apply to the cabinet, cosmetic parts, or batteries.

This warranty does not apply to uncrating, setup, installation, removal of the product for repair, or reinstallation of the product after repair.

This warranty does not apply to repairs or replacements necessitated by any cause beyond the control of SMC including, but not limited to, any malfunction, defect or failure caused by or resulting from unauthorized service or parts, improper maintenance, operation contrary to furnished instructions, shipping or transit accidents, modification or repair by the user, abuse, misuse, neglect, accident, incorrect line voltage, fire, flood or other Acts of God, or normal wear and tear.

The foregoing is in lieu of all other expressed warranties and SMC does not assume or authorize any party to assume for it any other obligation or liability.

THE DURATION OF ANY WARRANTIES WHICH MAY BE IMPLIED BY LAW (INCLUDING THE WARRANTIES OF MERCHANTABILITY AND FITNESS) IS LIMITED TO THE TERM OF THIS WARRANTY. IN NO EVENT SHALL SMC BE LIABLE FOR SPECIAL, INCIDENTAL OR CONSEQUENTIAL DAMAGES ARISING FROM OWNERSHIP OR USE OF THIS PRODUCT, OR FOR ANY DELAY IN THE PERFORMANCE OF ITS OBLIGATIONS UNDER THIS WARRANTY DUE TO CAUSES BEYOND ITS CONTROL.

SOME STATES DO NOT ALLOW LIMITATIONS ON HOW LONG AN IMPLIED WARRANTY LASTS AND/OR DO NOT ALLOW THE EXCLUSION OR LIMITATION OF CONSEQUENTIAL DAMAGES, SO THE ABOVE LIMITATIONS AND EXCLUSIONS MAY NOT APPLY TO YOU.

THIS WARRANTY GIVES YOU SPECIFIC LEGAL RIGHTS. YOU MAY HAVE OTHER RIGHTS, WHICH VARY FROM STATE TO STATE.

For your protection in the event of theft or loss of this product, please fill in the information requested below and **KEEP** in a safe place for your own personal records.

Model No. _____

Serial No. _____

(Located on back.)

Date of Purchase _____

Purchase Price _____

Where Purchased _____